

FlowCon EVS

**Plug-in Insert for Temperature Control
of Automatic Balancing Valve
15-25 mm / 1/2"-1"**



SPECIFICATIONS

Insert:

Static pressure:	2500 kPa / 360 psi
Ambient temperature:	0°C to +60°C / +32°F to +140°F
Media temperature ¹ :	-20°C to +120°C / -4°F to +248°F
Material:	
- Body:	Brass ASTM B584 and POM
- Insert:	Stainless steel AISI type 304
- Spring:	Stainless steel type 17-7
- Spindle:	Brass
- O-rings and seat:	EPDM
Stroke:	3.3 mm
Maximum close off pressure:	400 kPa / 58 psi
Shut-off leakage:	ANSI / FCI 70-2 2006, Class V / IEC 60534-4, Class V
Flow rate range:	0.0210-0.631 l/sec (0.333-10.0 GPM)

Valve:

Material:	
- Housing:	Forged brass ASTM CuZn40Pb2 or DZR ASTM CuZn36Pb2As
- Ball valve:	ABV: Chemically nickel-plated brass ball
End Connections ² :	A: Fixed female ISO or NPT AB: Fixed female ISO or NPT ABV: Union end connections in brass alloy ISO or NPT
Housing taps:	AB/ABV: 1/4" ISO

Note 1: Stated temperature rating is defined due to no external spindle condensation.
Note 2: NPT only available ex. US-factory.

SPECIFICATIONS (...continued)

FlowCon Actuators:

FlowCon Actuator ²	EV.0.2	EV.0.3	EVP.0.3	EV.0.4	EV.0.5	EV.1.3	EV.1.4
Supply voltage	24V AC -10%/+20% 50/60 Hz	230V AC ±10% 50/60 Hz	230V AC ±10% 50/60 Hz	24V AC/DC -10%/+20% 50/60 Hz	120V AC ±10% 50/60 Hz	230V AC ±10% 50/60 Hz	24V AC/DC -10%/+20% 50/60 Hz
Type	Thermal	Thermal	Thermal	Thermal	Thermal	Thermal	Thermal
Power consumption	1.0 watt	1.0 watt	2.0 watt	1.0 watt	1.0 watt	1.0 watt	1.0 watt
Control signal	0-10V DC normally closed ³	ON/OFF normally closed ³	ON/OFF normally closed ³	ON/OFF normally closed ³	ON/OFF normally closed ³	ON/OFF normally closed ³	ON/OFF normally closed ³
Failsafe function	Yes	Yes	Yes	Yes	Yes	Yes	Yes
Operation time ⁴	Approx. 2.5 min	Approx. 4 min	Approx. 3 min	Approx. 4 min	Approx. 4 min	Approx. 4 min	Approx. 4 min
Ambient temperature	0°C to +60°C	0°C to +60°C	0°C to +60°C	0°C to +60°C	0°C to +60°C	0°C to +60°C	0°C to +60°C
Protection	IP54 including upside-down, class III	IP54 including upside-down, class II	IP54 including upside-down, class II	IP54 including upside-down, class III	IP54 including upside-down, class II	IP54 including upside-down, class II	IP54 including upside-down, class III
Cable	Plug-in, 1 m / 3 ft	Fixed, 1 m / 3 ft	Fixed, 1 m / 3 ft	Fixed, 1 m / 3 ft	Fixed, 1 m / 3 ft	Fixed, 1 m / 3 ft	Fixed, 1 m / 3 ft
Weight	0.119 kg (0.262 lbs)	0.108 kg (0.238 lbs)	0.108 kg (0.238 lbs)	0.108 kg (0.238 lbs)	0.108 kg (0.238 lbs)	0.158 kg (0.348 lbs)	0.158 kg (0.348 lbs)
Including end switch	No	No	No	No	No	Yes	Yes
Switching point	N/A	N/A	N/A	N/A	N/A	Approx. 2 mm / 0.08 in	Approx. 2 mm / 0.08 in
Switching capacity	N/A	N/A	N/A	N/A	N/A	230V AC 5A ohm resistive load 1A inductive load	24V AC 3A ohm resistive load 1A inductive load

Note 2: FlowCon warranty is voided using other actuators than supplied or recommended by FlowCon International.

Note 3: To ensure that the valve is in an open position during commission of the system, the actuator will be delivered in a normal open position and remain in this position until it is electrically operated first time.

Note 4: Closing time is approximately the double dependent on ambient temperature.

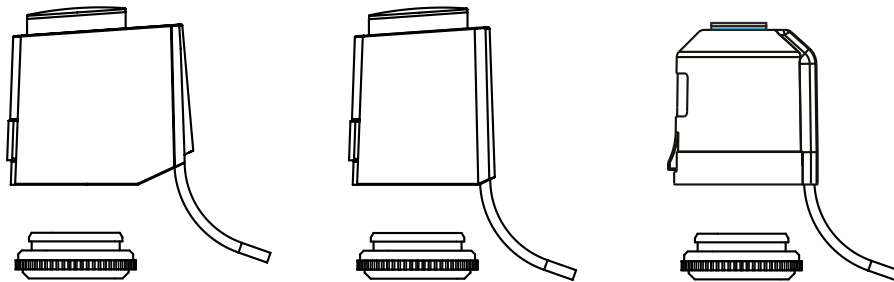

*FlowCon EV.0.2,
EV.1.3 and EV.1.4
Valve adaptor, black*

*FlowCon EV.0.3,
EV.0.4 and EV.0.5
Valve adaptor, black*

*FlowCon EVP.0.3
Valve adaptor, black*

DIMENSIONS AND WEIGHT (NOMINAL)

Model no.	Valve model	Valve size mm (in)	Insert size mm (in)	L mm (in)	H1 mm (in)	H2 EV.0.2/1.3/ 1.4 act. mm (in)	H3 EV.0.3/0.4/ 0.5 act. mm (in)	H4 EVP actuator mm (in)	End connections C ⁵			Weight ⁶ kg (lb)
									Female ISO (NPT)	Male ISO (NPT)	Sweat ISO (NPT)	
EVS.X.04	A	15 (1/2)	20 (3/4)	80 (3.15)	30.6 (1.21)	120 (4.72)	117 (4.61)	110 (4.33)	-	-	-	0.54 (1.19)
EVS.X.05		20 (3/4)										0.50 (1.10)
EVS.X.06		25 (1)										0.60 (1.32)
EVS.X.01	AB	15 (1/2)	20 (3/4)	81 (3.19)	30.6 (1.21)	120 (4.72)	117 (4.61)	110 (4.33)	-	-	-	0.50 (1.11)
EVS.X.02		20 (3/4)										0.52 (1.14)
EVS.X.09		25 (1)										0.72 (1.59)
EVS.X.03	ABV	15 (1/2)	20 (3/4)	122 (4.80)	33.0 (1.30)	120 (4.72)	117 (4.61)	110 (4.33)	22 (0.87)	24 (0.95)	20 (0.79)	0.90 (1.98)
		22 (0.87)							25 (0.99)	20 (0.79)		
		-							39 (1.54)	22 (0.87)		

Note 5: Add end connection length to body length.

Note 6: Weight does not include end connections or actuator.

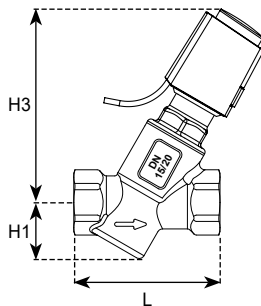

*FlowCon EVS in FlowCon A valve
DN15/20/25 (1/2", 3/4", 1")
with EV.0.3/0.4/0.5 actuator*

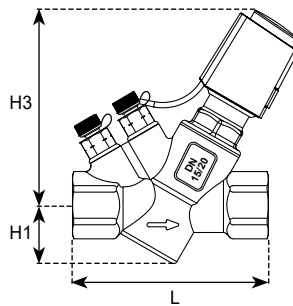

*FlowCon EVS in FlowCon AB valve
DN15/20/25 (1/2", 3/4", 1")
with EV.0.3/0.4/0.5 actuator*

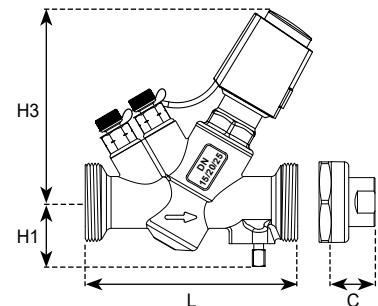

*FlowCon EVS in FlowCon ABV1 valve
DN15/20/25 (1/2", 3/4", 1")
with EV.0.3/0.4/0.5 actuator*

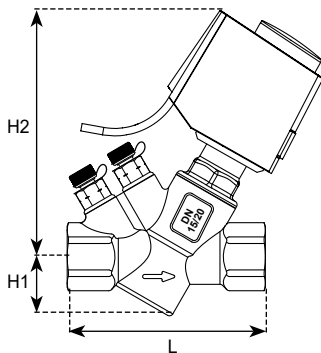

*FlowCon EVS in FlowCon AB valve
DN15/20/25 (1/2", 3/4", 1")
with EV.0.2/1.3/1.4 actuator*

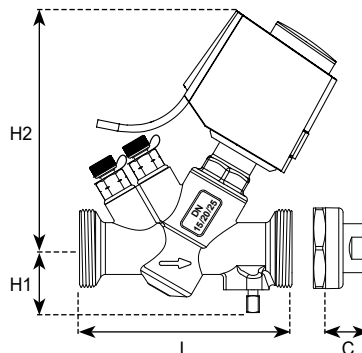

*FlowCon EVS in FlowCon ABV1 valve
DN15/20/25 (1/2", 3/4", 1")
with EV.0.2/1.3/1.4 actuator*

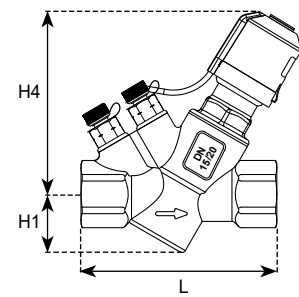

*FlowCon EVS in FlowCon AB valve
DN15/20/25 (1/2", 3/4", 1")
with EVP.0.3 actuator*

MODEL NUMBER SELECTION

EVS

Insert type of actuator:
2=EV.0.2 **3**=EV.0.3 **4**=EV.0.4 **5**=EV.1.3 **6**=EV.1.4 **7**=EV.0.5 **8**=EVP.0.3

Insert type of body:
01=AB DN15, 1/2" **02**=AB DN20, 3/4" **03**=ABV1 DN15-25, 1/2"-1"
04=A DN15, 1/2" **05**=A DN20, 3/4" **06**=A DN25, 1" **09**=AB DN25, 1"

Insert p/t plug requirements:
B=pressure/temperature plugs **P**=taps plugged - leave **blank** if A-body or no p/t plugs required

Insert inlet x outlet union end connections - leave **blank** if A- or AB-body or no end connections required:

Body model and size	Female threaded	Male treaded	Sweat	
Union end 15-25 mm, 1/2"-1"	E = 15 mm / 1/2" F = 20 mm / 3/4"	H = 15 mm / 1/2" I = 20 mm / 3/4" J = 25 mm / 1"	K = 15 mm L = 18 mm M = 22 mm	O = 1/2" R = 3/4" U = 1"

Insert connection standard:
I=ISO **N**=NPT

Insert kPaD control range:
1=10-95 kPaD **2**=22-210 kPaD **4**=40-390 kPaD - leave **blank** if no insert is required

Insert automatic flow limiting insert code:
 (Determine from insert selection chart)

Example: EVS.2.01.P.I.F360206.2=EV5 insert in AB 15 mm (1/2") ISO female threaded body with plugs, 24V modulating actuator and a F360206 insert (0.189 l/sec, 22-210 kPaD) (3.00 GPM, 2-32 psid).

WIRING INSTRUCTION

FlowCon EV.0.2

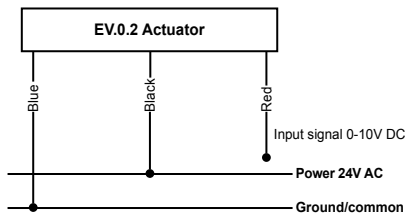

FlowCon EV.0.3 / EVP.0.3 / EV.0.4

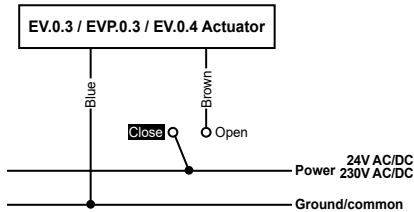

FlowCon EV.0.5

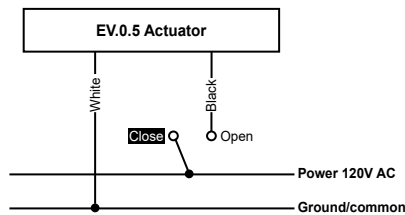

FlowCon EV.1.3 / EV.1.4

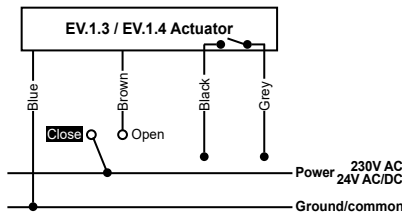

DESCRIPTION

The standard actuators available for the FlowCon EVS valve are thermal actuators that operate ON/OFF on 24V AC/DC, 120V AC and 230V AC or modulating on 24V AC respectively. ON/OFF actuators are available with end switches which can be used for controlling the fan in priority to the open position of the valve.

The EVS-insert with stainless steel insert will in connection with the FlowCon A, AB and ABV1 valve housings provide temperature control and dynamic balancing for use in cooling ceilings, fan coil units in air-condition or as zone valve in heating systems.

FLOW RATE TABLE

20mm · 3/4" stainless steel insert									
Nominal flow rate	Pressure range, ΔP:			10-95 kPaD 1-14 psid		22-210 kPaD 2-32 psid		40-390 kPaD 4-57 psid	
	l/sec	l/hr	GPM	Type 1		Type 2		Type 4	
				Marking	FlowCon	Marking	FlowCon	Marking	FlowCon
0.0210	75.7	0.333	11-1	F360111					
0.0315	114	0.500	01-1	F360101					
0.0347	125	0.550			11-2	F360211			
0.0421	151	0.667	02-1	F360102					
0.0473	170	0.750			01-2	F360201	11-4	F360411	
0.0631	227	1.00	03-1	F360103	02-2	F360202	01-4	F360401	
0.0694	250	1.10							
0.0841	303	1.33	04-1	F360104			02-4	F360402	
0.0946	341	1.50			03-2	F360203			
0.105	379	1.67	05-1	F360105					
0.126	454	2.00	06-1	F360106	04-2	F360204	03-4	F360403	
0.147	530	2.33	07-1	F360107					
0.158	568	2.50			05-2	F360205			
0.168	606	2.67	08-1	F360108			04-4	F360404	
0.189	681	3.00			06-2	F360206			
0.210	757	3.33	10-1	F360110			05-4	F360405	
0.221	795	3.50			07-2	F360207			
0.252	908	4.00	12-1	F360112	08-2	F360208	06-4	F360406	
0.294	1060	4.67	14-1	F360114			07-4	F360407	
0.315	1140	5.00	16-1	F360116	10-2	F360210			
0.336	1210	5.33					08-4	F360408	
0.379	1360	6.00			12-2	F360212			
0.421	1511	6.67					10-4	F360410	
0.442	1590	7.00			14-2	F360214			
0.505	1820	8.00			16-2	F360216	12-4	F360412	
0.589	2120	9.33					14-4	F360414	
0.631	2270	10.0					16-4	F360416	

Accuracy: ±5% of controlled flow rate.

ACCESSORIES

- P/t plugs: 2 x ACC00113
- Plugs and gaskets: 2 x ACC1B03000
- Spare part, black composite part: EVS.0.0.1.

GENERAL SPECIFICATIONS

1. AUTOMATIC BALANCING AND TEMPERATURE CONTROL VALVES

- FLOWCON EVS

- 1.1. Contractor shall install balancing / temperature valves where indicated in drawings.
- 1.2. The flow limiting device shall be available as a plug-in device for an inline valve housing.
- 1.3. Valve housing shall be configured for flow regulation unit accessibility.
- 1.4. Valve housing shall be permanently marked to show direction of flow.

2. VALVE ACTUATOR

- 2.1. Actuator housing shall be rated to IP54, including upside-down mounting.
- 2.2. Actuator shall be driven by 24V or 230V AC, and shall depending on actuator choice accept 0-10V DC or ON/OFF control signal.
- 2.3. Actuator shall use full stroke and provide full authority.
- 2.4. Actuator shall have visible indication of stroke position.
- 2.5. Failsafe function shall be available on all versions.

3. VALVE INSERT

- 3.1. The insert shall consist of forged brass ASTM B584 and POM, rated at no less than 2500 kPa (360 psi) static pressure and +120°C (+248°F).
- 3.2. The insert shall include a lock-ring for fast fitting and re-fitting of flow regulation unit.
- 3.3. The valve shall withstand a shut-off pressure of at least 400 kPa (58 psi) without allowing internal leakage.
- 3.4. The seat plug shall be manufactured of EPDM rubber.
- 3.5. The packing gland for sealing the stem shall be removable with the system in operation, without allowing external leakage.

4. VALVE HOUSING

4.a. FlowCon A

- 4.a.1. Valve housing shall consist of forged brass ASTM CuZn40Pb2, rated at no less than 2500 kPa (360 psi) static pressure and +120°C (+248°F).

OR....

4.b. FlowCon AB

- 4.b.1. Valve housing shall consist of forged brass ASTM CuZn40Pb2 or DZR brass ASTM CuZn36Pb2As, rated at no less than 2500 kPa (360 psi) static pressure and +120°C (+248°F).
- 4.b.2. Pressure/temperature test plugs for verifying accuracy of flow performance shall be available for all valve sizes.

OR....

4.c. FlowCon ABV

- 4.c.1. Valve housing shall consist of forged brass ASTM CuZn40Pb2, rated at no less than 2500 kPa (360 psi) static pressure and +120°C (+248°F).
- 4.c.2. Valve housing shall be double union end constructed with a range of pipe connections available for the appropriate pipe size.
- 4.c.3. Valve ball shall consist of chemically nickel plated brass (ASTM CuZn40Pb2).
- 4.c.4. Pressure/temperature test plugs for verifying accuracy of flow performance shall be available for all valve sizes.

5. FLOW REGULATION UNIT

- 5.1. Flow regulation unit assembly shall be manufactured of AISI type 304 stainless steel and stainless steel 17-7 spring.
- 5.2. Flow regulation unit shall be readily accessible for change-out or maintenance.
- 5.3. Flow regulation unit shall be available in 3 different operational pressure ranges, minimum range shall be capable of being activated by 10 kPaD (1 psid). Further, the flow regulation unit shall be capable of controlling flow within $\pm 5\%$ of rated flow.
- 5.4. Identification tag shall be available for all valves; tag shall be indelibly marked with part number and flow rate.

APPLICATION AND SCHEMATIC EXAMPLE

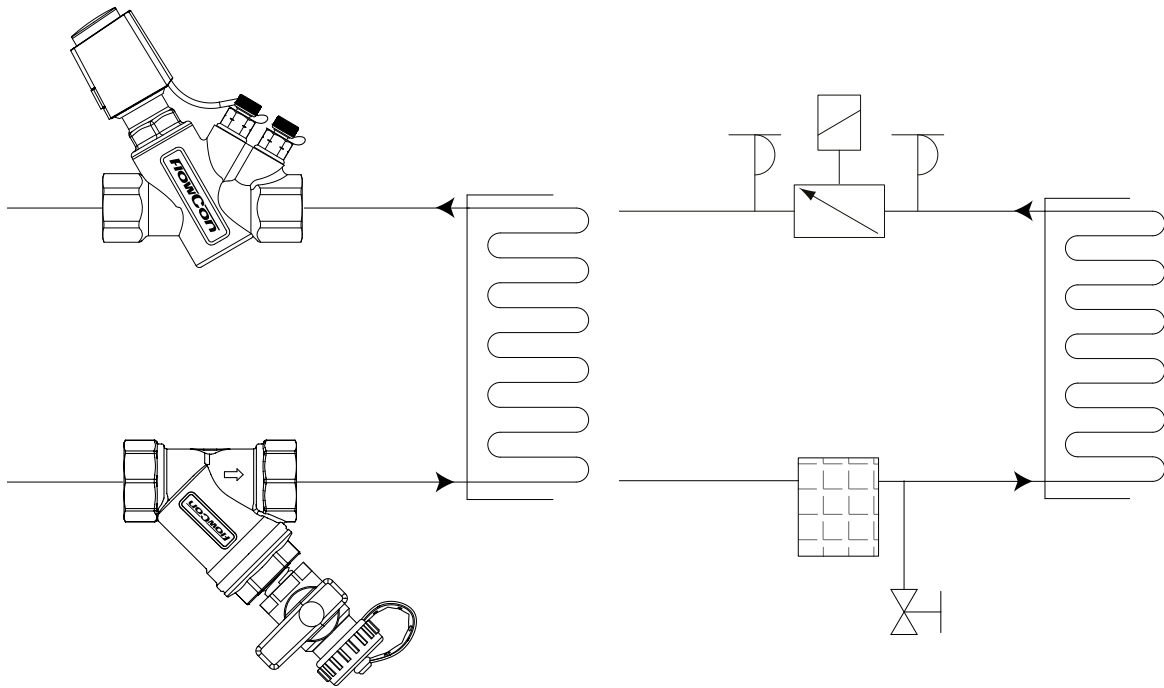

UPDATES

For latest updates please see www.flowcon.com

FlowCon International can accept no responsibility for possible errors in any printed material.
All rights reserved.